

# 4-20 mA Controller/Alarm Indicator

Model : CT-2012



Your purchase of this 4 to 20 mA CONTROLLER marks a step forward for you into the field of precision measurement. Although this METER is a complex and delicate instrument, its durable structure will allow many years of use if proper operating techniques are developed. Please read the following instructions carefully and always keep this manual within easy reach.

**OPERATION MANUAL**

## Caution Symbol

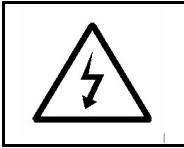

**Caution :**

- \* Risk of electric shock !



**Caution :**

- \* Do not use fingers or any tool to touch the Wire Terminals.
- \* Do not apply the relay contact load current > 0.5 Amp.
- \* The instrument contains no user serviceable parts and should not be opened by the user.
- \* Repair or after service should be done by a qualified technician only.
- \* Power supply should apply the correct ACV power voltage
- \* Cleaning - Only use the dry cloth to clean the plastic case !

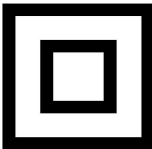

- \* **Equipment protected throughout by Double Insulation or Reinforced Insulation.**

## Environmental Condition

- \* Comply with EN61010.  
Transient over voltage at Mains Supply 2500V.
- \* Pollution Degree 2.
- \* Altitude up to 2000 meters.
- \* Indoor use.
- \* Relative humidity 80% max.

# TABLE OF CONTENTS

1. FEATURES.....	1
2. SPECIFICATIONS.....	2
3. FRONT PANEL DESCRIPTION.....	5
3-1 Display.....	5
3-2 PV ( process value ) indicator.....	5
3-3 SV ( set value ) indicator.....	5
3-4 Set Button.....	5
3-5 ▼ Button.....	5
3-6 ▲ Button.....	5
3-7 Control relay indicator.....	5
3-8 Alarm relay indicator.....	5
3-9 Wire terminals.....	5
3-10 Case holder .....	5
3-11 RS232 terminal.....	5
4. MEASURING PROCEDURE .....	6
4-1 Terminal connection.....	6
4-2 1st layer setting procedures.....	7
a. Control Low limit value setting.....	7
b. Control High limit value setting.....	7
c. Alarm Low limit value setting.....	8
d. Alarm High limit value setting.....	8
4-3 2nd layer setting procedures.....	9
a. Point position setting.....	9
b. 4 mA value setting.....	9
c. 20 mA value setting.....	10
d. Digital filter value setting.....	10
e. Control hysteresis value setting.....	11
f. Alarm hysteresis value setting.....	12
g. Offset value adjustment.....	13
h. Gain value setting.....	13
i. RS232 output unit code setting.....	14
5.. RS232 PC SERIAL INTERFACE.....	14
6. SYSTEM RESET.....	17
7. THE ADDRESS OF AFTER SERVICE CENTER.....	17

# 1. FEATURES

- \* Input : 4-20 mA DC, linear.
- \* User can default the desired display value between -1999 to 9999 ( decimal point can be selected to DP1, DP2, DP3 ) and all the preset data will be saved into the memory circuit permanently.
- \* According the 4 to 20 mA input signal, user can preset the desire display value between -1999 to 9999 ( decimal point can select to DP1, DP2, DP3 ). Until set the display value, all the data will save into the memory circuit permanently
- \* When CT-2012 cooperate LUTRON's 4 to 20 mA transmitters ( or any other transmitters if it build 4 to 20 mA output signal ), whole system will become the high performance Controller/Alarm/Indicator for following measuring functions : Humidity, Light, pH, Dissolved Oxygen, Conductivity, Vibration, Pressure, Sound, Temperature, RPM, Hz, Load cell ( Weight, Force ), Potential ( Angle, Level ). ACV, ACA, DCV, DCA, WATT....
- \* Easy to adjust the function factors by push button on the front panel.
- \* Control output : 2 points ( COM, NO ).
- \* Alarm output : 2 points ( COM, NO ).
- \* Control Relay will make action when the reading value reach to control value.
- \* Hysteresis value setting for control and alarm function.
- \* Large red LED display, high brightness and easy to read.
- \* Microprocessor circuit ensures high accuracy and provides special functions and features.
- \* DC 12V power supply output.
- \* RS232/USB computer interface.
- \* Power : 90 ACV - 264 ACV, 50/60 Hz.
- \* Standard 96 X 48 mm DIN case.
- \* Optional data acquisition software.

## 2. SPECIFICATIONS

Display	* 4 digits red LED, 14 mm ( 0.55 inch ) digit height	
	* 4 indicators : PV ( process value ) indicator SV ( set value ) indicator Control out indicator Alarm out indicator	
	* According the 4-20 mA input signal, user can preset the desire display value between -1999 to 9999 ( decimal point can select to DP1, DP2, DP3 ). Until set the display value, all the data will save into the memory circuit permanently	
Input Signal	Linear, 4 to 20 mA	
Circuit	Custom chip of microprocessor LSI circuit.	
Sampling Time	Approx. 1 second.	
Relay Output	Number	2 relays
	Function	<i>Relay 1 :</i> High/Low control relay. <i>Relay 2 :</i> High/Low alarm relay.
	Max load	0.5 ACA/250 ACV 0.5 DCA/24 DCV <b>* Do not apply the relay contact load current &gt; 0.5 A, other wise the relay may be damaged permanently without warranty.</b>
		

Main Internal Function Selection	<ul style="list-style-type: none"> <li>* Decimal point adjustment : DP1, DP2, DP3</li> <li>* Low limit of range adjustment 4 mA = X X X X, min. value is -1999</li> <li>* High limit of range adjustment 20 mA = X X X X, max. value is 9999</li> <li>* Alarm value adjustment : High Alarm or Low alarm.</li> <li>* Control value adjustment High control or Low control.</li> <li>* Control hysteresis value setting.</li> <li>* Alarm hysteresis value setting.</li> <li>* Filter value of display reading</li> <li>* Offset adjustment.</li> <li>* Gain adjustment.</li> <li>* RS232 output unit code setting</li> </ul> <p>Default of internal function : Without advice previously, the function of CT-2012 will preset :</p> <ul style="list-style-type: none"> <li>* 4 mA = 0, 20 mA = 9999.</li> <li>* High control mode.</li> <li>* High alarm mode.</li> <li>* RS232 output unit code = 0 ( no unit ).</li> </ul>
Front Panel Function Selection	<ul style="list-style-type: none"> <li>* Control set-point value adjustment.</li> <li>* Measuring value ( Process value ) offset. Use to offset the PV indication from the actual PV.</li> <li>* Alarm set-point value adjustment.</li> </ul>
External Power Supply	DC 12 V, 50 mA max.
Data Output	RS 232 PC serial interface.
Operating Temperature	0 to 50 °C.
Operating Humidity	Less than 80% R.H.

Power Supply	90 to 260 ACV, 50/60 Hz.
Power Consumption	Approx. 3.5 VA/AC 110V. Approx. 4.9 VA/AC 220V.
Weight	384 g/ 0.84 LB.
Dimension	DIN size : 96 x 48 mm. Panel cut size : 92 mm x 46 mm. Depth : 110 mm.
Accessories Included	Instruction manual.....1 PC Case holder with screw.....2 PCs
Optional Accessories	* Data Acquisition software, SW-U801-WIN. * RS232 cable, UPCB-02. * USB cable, USB-01.

### 3. FRONT PANEL DESCRIPTION

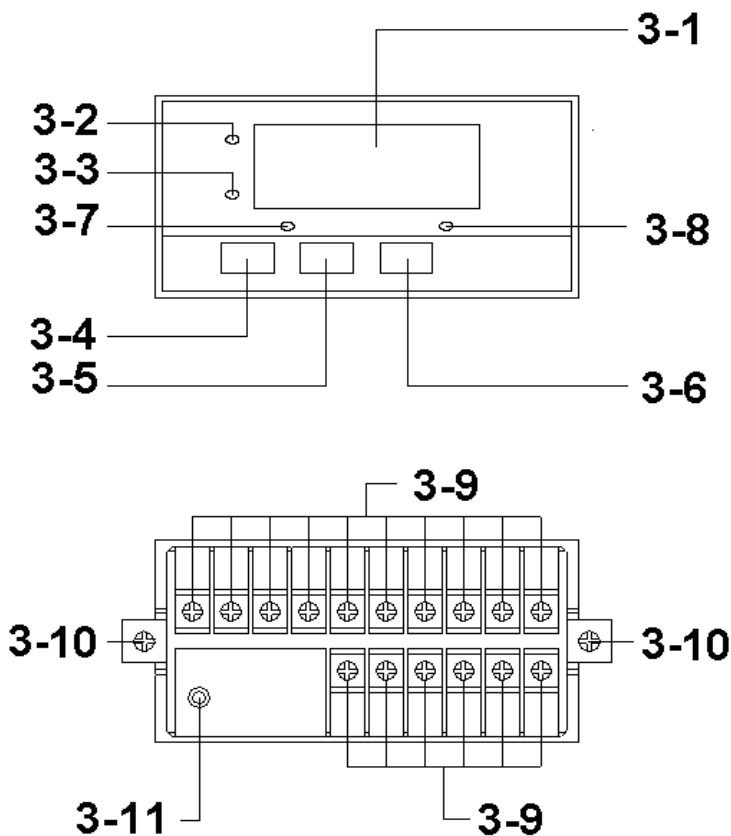
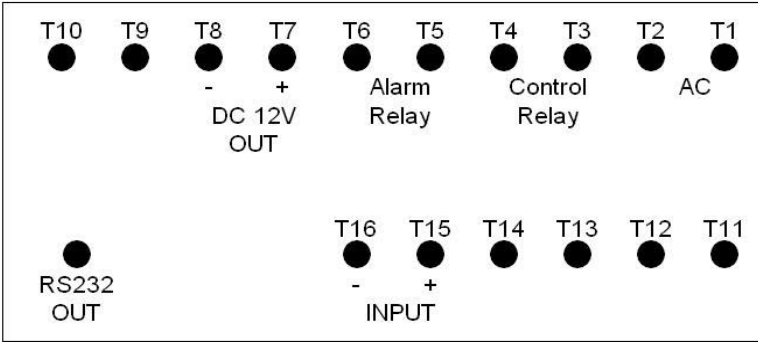

Fig. 1

- 3-1 Display
- 3-2 PV ( process value ) indicator
- 3-3 SV ( set value ) indicator
- 3-4 Set Button
- 3-5 ▼ Button
- 3-6 ▲ Button
- 3-7 Control relay indicator
- 3-8 Alarm relay indicator
- 3-9 Wire terminals
- 3-10 Case holder
- 3-11 RS232 terminal



## 4. MEASURING PROCEDURE



### 4-1 Terminal connection

- 1) Input the ACV power ( 90 to 260 ACV ) to T1, T2.



**Do not input the over voltage to the AC input terminals.**

- 2) Connect the " Control Relay " output from T3, T4.  
Connect the " Alarm Relay " output from T5, T6.
- 3) Connect the input signal ( 4 to 20 mA DC ) to the input terminal T15 (+), T16 (-).
- 4) T7 (+), T8 ( - ) are DC 12 V power supply terminal.  
If the measured installation ( transmitters ) need the the external DC 12V power supply, can connect its power supply from T7, T8.

## 4-2 1st layer setting procedures

<b>CtLo</b>	<b>Control Low limit value setting</b>
<b>CtHi</b>	<b>Control High limit value setting</b>
<b>ALLo</b>	<b>Alarm Low limit value setting</b>
<b>ALHi</b>	<b>Alarm High limit value setting</b>

### **a. Control Low limit value setting**

- 1) Press the " Set Button " ( 3-4, Fig. 1 ) once, the " Display " will show " CtLo ", now the meter is ready for the " Control Low limit value " setting.
- 2) Use the " ▼ Button " ( 3-5, Fig. 1 ) and the " ▲ Button " ( 3-6, Fig. 1 ) to adjust the desiring " Control Low limit value ", press the " Set Button " ( 3-4, Fig. 1 ) to save the setting value.

*Remark :*

- \* *During adjust the value, the " SV indicator " ( 3-3, Fig. 1 ) will light.*
- \* *The function of " Control Low limit value " setting, refer to page 11, Fig. 3.*

### **b. Control High limit value setting**

- 1) After finish above " Control Low limit value setting ", press the " Set Button " ( 3-4, Fig. 1 ) once, the " Display " will show " CtHi ", now the meter is ready for the " Control High limit value " setting.
- 2) Use the " ▼ Button " ( 3-5, Fig. 1 ) and the " ▲ Button " ( 3-6, Fig. 1 ) to adjust the desiring " Control High limit value ", press the " Set Button " ( 3-4, Fig. 1 ) to save the setting value.

*Remark :*

- \* *When adjust the value, the " SV indicator " ( 3-3, Fig. 1 ) will light.*
- \* *The function of " Control High limit value " setting, refer to page 11, Fig. 3.*

### **c. Alarm Low limit value setting**

- 1) After finish above " Control High limit value setting ", press the " Set Button " ( 3-4, Fig. 1 ) once, the " Display " will show " ALLo ", now the meter is ready for the " Alarm Low limit value " setting.
- 2) Use the " ▼ Button " ( 3-5, Fig. 1 ) and the " ▲ Button " ( 3-6, Fig. 1 ) to adjust the desiring " Alarm Low limit value ", press the " Set Button " ( 3-4, Fig. 1 ) to save the setting value.

*Remark :*

- \* *When adjust the value, the " SV indicator " ( 3-3, Fig. 1 ) will light.*
- \* *The function of " Alarm Low limit value " setting, refer to page 12, Fig. 4.*

### **d. Alarm High limit value setting**

- 1) After finish above " Alarm Low limit value setting ", press the " Set Button " ( 3-4, Fig. 1 ) once, the " Display " will show " ALHi ", now the meter is ready for the " Alarm High limit value " setting.
- 2) Use the " ▼ Button " ( 3-5, Fig. 1 ) and the " ▲ Button " ( 3-6, Fig. 1 ) to adjust the desiring " Alarm High limit value ", press the " Set Button " ( 3-4, Fig. 1 ) to save the setting value.

*Remark :*

- \* *During adjust the value, the " SV indicator " ( 3-3, Fig. 1 ) will light.*
- \* *The function of " Alarm Low limit value " setting, refer to page 12, Fig. 3.*

### **4-3 2nd layer setting procedures**

<b>dPSt</b>	<b>Point position setting</b>
<b>4-A</b>	<b>4 mA value setting</b>
<b>20-A</b>	<b>20 mA value setting</b>
<b>FiLt</b>	<b>Digital filter setting</b>
<b>CtHy</b>	<b>Control hysteresis value setting</b>
<b>ALHy</b>	<b>Alarm hysteresis value setting</b>
<b>oFSt</b>	<b>Offset value setting</b>
<b>GAin</b>	<b>Gain value setting</b>
<b>Unit</b>	<b>RS232 output unit code setting</b>

#### **a. Point position setting**

- 1) Press the " Set Button " ( 3-4, Fig. 1 ) continuously at least two seconds, the " Display " will show " dPSt ", now the meter is ready for the " Point position Setting ".
- 2) Use the " ▼ Button " ( 3-5, Fig. 1 ) and the " ▲ Button " ( 3-6, Fig. 1 ) to adjust the desiring " Point position ", press the " Set Button " ( 3-4, Fig. 1 ) to save the setting value.

*Remark :*

*\* During adjust the value, the " SV indicator " ( 3-3, Fig. 1 ) will light.*

#### **b. 4 mA value setting**

- 1) After finish the " Point position ", press the " Set Button " ( 3-4, Fig. 1 ) once, the " Display " will show " 4-A ", now the meter is ready for the " 4 mA value " setting, for example 4 mA input signal = 0 or other value upon user own requirement.
- 2) Use the " ▼ Button " ( 3-5, Fig. 1 ) and the " ▲ Button " ( 3-6, Fig. 1 ) to adjust the desiring " 4 mA value ", press the " Set Button " ( 3-4, Fig. 1 ) to save the setting value.

*Remark :*

*\* During adjust the value, the " SV indicator " ( 3-3, Fig. 1 ) will light.*

### **c. 20 mA value setting**

- 1) After finish the " 4 mA value setting", press the " Set Button " ( 3-4, Fig. 1 ) once, the " Display " will show " 20-A ", now the meter is ready for the " 20 mA value " setting, for example 20 mA input signal = 100 or other value upon user own requirement.
- 2) Use the " ▼ Button " ( 3-5, Fig. 1 ) and the " ▲ Button " ( 3-6, Fig. 1 ) to adjust the desiring " 20 mA value ", press the " Set Button " ( 3-4, Fig. 1 ) to save the setting value.

*Remark :*

*\* During adjust the 20 mA value, the " SV indicator " ( 3-3, Fig. 1 ) will light.*

### **d. Digital filter value setting**

- 1) After finish the " 20 mA value setting", press the " Set Button " ( 3-4, Fig. 1 ) once, the " Display " will show " FilT ", now the meter is ready for the " Digital filter value " setting.
- 2) Use the " ▼ Button " ( 3-5, Fig. 1 ) and the " ▲ Button " ( 3-6, Fig. 1 ) to adjust the desiring " Digital filter value ", press the " Set Button " ( 3-4, Fig. 1 ) to save the setting value.

*Remark :*

*\* During adjust the value, the " SV indicator " ( 3-3, Fig. 1 ) will light,*

*\* The setting range of " Digital filter value " is from 1 to 99. the default value is 1.*

*\* The more value will get more " Digital filters ", the Display will be more stable, however the more " Digital filter value " the response time of Display will be slowly.*

### e. Control hysteresis value setting

- 1) After finish the " Digital filter value setting ", press the " Set Button " ( 3-4, Fig. 1 ) once, the " Display " will show " CtHy ", now the meter is ready for the " Control Hysteresis value " setting.
- 2) Use the " ▼ Button " ( 3-5, Fig. 1 ) and the " ▲ Button " ( 3-6, Fig. 1 ) to adjust the desiring " Control Hysteresis value ", press the " Set Button " ( 3-4, Fig. 1 ) to save the setting value.

Remark :

- \* During adjust the value ", the " SV indicator " ( 3-3, Fig. 1 ) will light.
- \* The function of " Control Hysteresis value " setting, refer to following Fig. 3.

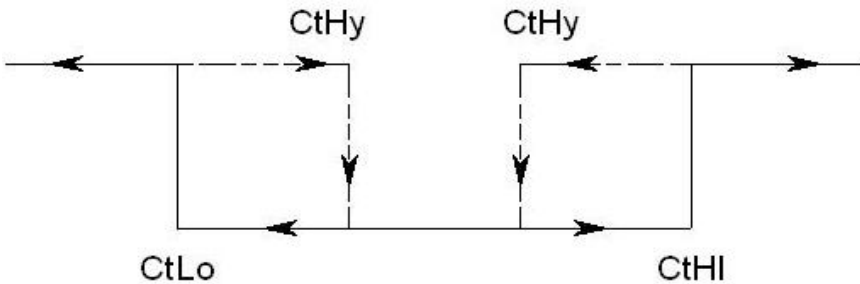

\* For example :

Fig. 3

Control high limit value ( CtHi ) : 500

Control low limit value ( CtLo ) : 100

Control Hysteresis value ( CtHy ) : 5

- a. The control relay will On when measuring value up to 500. The control relay will Off again when measuring value down to 495.
- b. The control relay will On when measuring value down to 100. The control relay will Off when measuring value up to 105.

## f. Alarm hysteresis value setting

- 1) After finish the " Control Hysteresis value setting " , press the " Set Button " ( 3-4, Fig. 1 ) once, the " Display " will show " ALHy ", now the meter is ready for the " Alarm Hysteresis value " setting.
- 2) Use the " ▼ Button " ( 3-5, Fig. 1 ) and the " ▲ Button " ( 3-6, Fig. 1 ) to adjust the desiring " Alarm Hysteresis value " , press the " Set Button " ( 3-4, Fig. 1 ) to save the setting value.

*Remark :*

- \* *During adjust the value " , the " SV indicator " ( 3-3, Fig. 1 ) will light.*
- \* *The function of " Alarm Hysteresis value " setting, refer to following Fig. 4.*

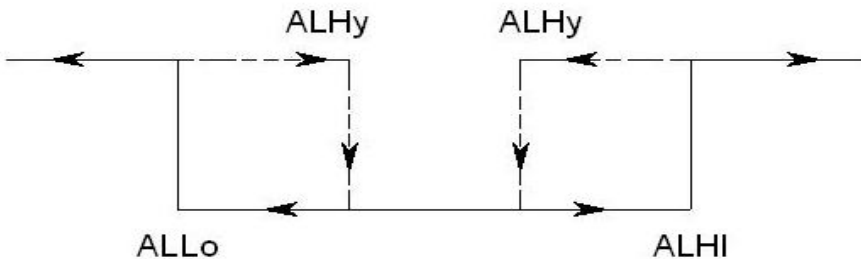

Fig. 4

\* For example :

Alarm High limit value ( ALHi ) : 100

Alarm Low limit value ( ALLo ) : 20

Alarm Hysteresis value ( ALHy ) : 5

- a. The alarm relay will On when measuring value up to 100. The alarm relay will Off again when measuring value down to 95.
- b. The alarm relay will On when measuring value down to 20. The alarm relay will Off when measuring value up to 25.

### **g. Offset value adjustment**

- 1) After finish the " Alarm hysteresis value setting " , press the " Set Button " ( 3-4, Fig. 1 ) once, the " Display " will show " oFSt ", now the meter is ready for the " Offset value adjustment " setting.
- 2) Use the " ▼ Button " ( 3-5, Fig. 1 ) and the " ▲ Button " ( 3-6, Fig. 1 ) to adjust the desiring " Offset value ", press the " Set Button " ( 3-4, Fig. 1 ) to save the setting value.

*Remark :*

- \* During adjust the value, the " SV indicator " ( 3-3, Fig. 1 ) will light.

### **h. Gain value setting**

- 1) After finish the " Offset value setting " , press the " Set Button " ( 3-4, Fig. 1 ) once, the " Display " will show " oFSt ", now the meter is ready for the " Gain value adjustment " setting.
- 2) Use the " ▼ Button " ( 3-5, Fig. 1 ) and the " ▲ Button " ( 3-6, Fig. 1 ) to adjust the desiring " Gain value ", press the " Set Button " ( 3-4, Fig. 1 ) to save the setting value.

*Remark :*

- \* During adjust the value, the " SV indicator " ( 3-3, Fig. 1 ) will light.
- \* The Gain value setting range is 0.001 to 9.999, the default value is 1.000.



## **i. RS232 output unit code setting**

- 1) After finish the " Gain value setting " , press the " Set Button " ( 3-4, Fig. 1 ) once, the " Display " will show " Unit ", now the meter is ready for the " RS232 output unit code " setting.
- 2) Use the " ▼ Button " ( 3-5, Fig. 1 ) and the " ▲ Button " ( 3-6, Fig. 1 ) to adjust the desiring " RS232 output unit code " no., press the " Set Button " ( 3-4, Fig. 1 ) to save the setting value.

*Remark :*

\* During adjust the unit code no., the " SV indicator " ( 3-3, Fig. 1 ) will light.

\* The RS232 output code list, please refer chapter 5, page 16.

## **5. RS232 PC SERIAL INTERFACE**

The instrument has RS232 PC serial interface via a 3.5 mm terminal ( 3-11, Fig. 1 ).

The data output is a 16 digit stream which can be utilized for user's specific application.

A RS232 lead with the following connection will be required to link the instrument with the PC serial port.

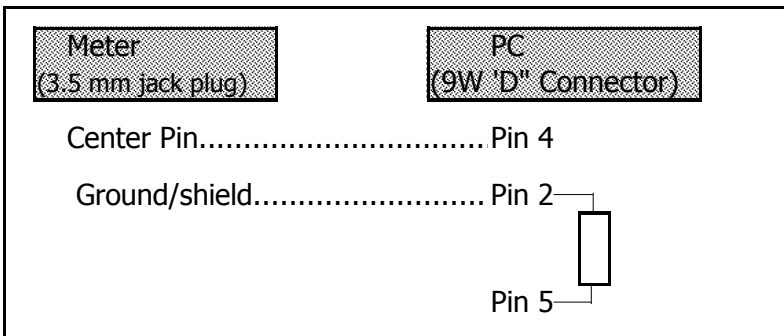

The 16 digits data stream will be displayed in the following format :

D15 D14 D13 D12 D11 D10 D9 D8 D7 D6 D5 D4 D3 D2 D1 D0

**Each digit indicates the following status :**

D15	Start Word
D14	4
D13	When send the upper display data = 1 When send the lower display data = 2
D12 & D11	Unit code no., refer to the table, page 16.
D10	Polarity 0 = Positive 1 = Negative
D9	Decimal Point(DP), position from right to the left 0 = No DP, 1= 1 DP, 2 = 2 DP, 3 = 3 DP
D8 to D1	Display reading, D8 = MSD, D1 = LSD. For example : If the display reading is 1234, then D8 to D1 is : 00001234
D0	End Word

**RS232 setting**

Baud rate	9600
Parity	No parity
Data bit no.	8 Data bits
Stop bit	1 Stop bit

## The RS232 output code list

00 = NO UNIT	33 = KHz	66 = mF
01 = C	34 = DCV	67 = MHz
02 = F	35 = DCuA	68 = uH
03 = %	36 = DCA	69 = dBm
04 = %RH	37 = DCmA	70 = Red
05 = pH	38 = ohm	71 = Gren
06 = %O2	39 = Kohm	72 = Blue
07 = mg/L	40 = Mohm	73 = Stau
08 = m/s	41 = mH	74 = mSEC
09 = knot	42 = H	75 = uSEC
10 = km/h	43 = nF	76 = SEC
11 = ft/m	44 = uF	77 = Kgc2
12 = ml/h	45 = hfe	78 = mmHg
13 = uS	46 = DIO	79 = mH2O
14 = mS	47 = WATT	80 = inHg
15 = Lux	48 = KWAT	81 = Kgcm
16 = Ftcd	49 = ACmV	82 = Lbin
17 = dB	50 = ACV	83 = N-cm
18 = mV	51 = ACuA	84 = CMM
19 = PPM	52 = ACA	85 = CFM
20 = mg	53 = ACmA	86 = mbar
21 = Tesl	54 = PF	87 = Pa
22 = bar	55 = Kg	88 = kPa
23 = PSI	56 = Lb	89 = uHg
24 = cmHg	57 = gram	90 = Torr
25 = iH2O	58 = oz	91 = hPa
26 = ATP	59 = NewT	92 = m/s2
27 = RPM	60 = m/m	93 = mm/s
28 = in/m	61 = Hour	94 = mm
29 = cm/m	62 = Min	95 = cm/s
30 = COUT	63 = VA	96 = inch
31 = Hz	64 = KVA	97 = FtS2
32 = DEG	65 = KWHR	98 = in/s

## 6. SYSTEM RESET

Power on the meter, use the two fingers to press " Set Button " ( 3-4, Fig. 1 ) and " ▼ Button " ( 3-7, Fig. 1 ) continuously more than 5 seconds until the Display show the text " rSt ", release the buttons. After " rSt " text flashing 2 times will return to the normal screen. The meter system will be reset, all the calibration data will be cleared, the meter's internal function will return the default value.

## 7. THE ADDRESS OF AFTER SERVICE CENTER

